

## Personalised 3D Audio for Headphones



- Precisely emulates up to 16 speakers in a sound room over stereo headphones
- Full suite of personalisation routines
- Internal audio bitstream decoding: Dolby Atmos, Auro-3D, DTS-X and all legacy Dolby and DTS formats
- Employs state-of-the-art SVS virtualisation with integrated head-tracking for realistic rendering
- Azimuth + elevation head-tracking
- Audio source inputs / outputs:
  - USB 2.0 : 16ch in / 2ch out
  - HDMI 2.0 : 8ch PCM i/o + bitstream in
  - Analogue : 16ch in + 16ch out
  - Optical : 2ch PCM i/o + bitstream in
- User interface and configuration via web browser
- Illusonic N:M channel upmixer
- Supports two simultaneous listeners with fully independent personalisation and head-tracking
- Hi-Mid-Lo headphone output gain modes
- Dedicated audio i/o for video gaming

The Realiser-A16 audio processor re-creates immersive 3D audio over stereo headphones, rendering up to sixteen virtual loudspeakers in any location, with head-tracking.

An integrated audio codec decoding board allows formats such as Dolby Atmos, Auro-3D and DTS:X to be decoded internally via the HDMI bitstream, Toslink optical or USB interfaces, and rendered automatically to an appropriate virtual loudspeaker format.

In addition, discrete audio signals can be sourced from USB 2.0 and analogue (16-ch), from HDMI (8-ch), and from SPDIF optical and stereo inputs (2-ch).

The versatile Illusonic N:M up-mixer allows all source material from 2.0 stereo up to 7.1 discrete surround to be upmixed and rendered to any 16-ch immersive or 3D loudspeaker format.

The headphone processor is configured via a web browser, and can then be controlled either from the front panel, or with an IR remote or from a web browser.

Low-latency convolution modes allow rendering for live audio performances and highly interactive video gaming.

## Applications

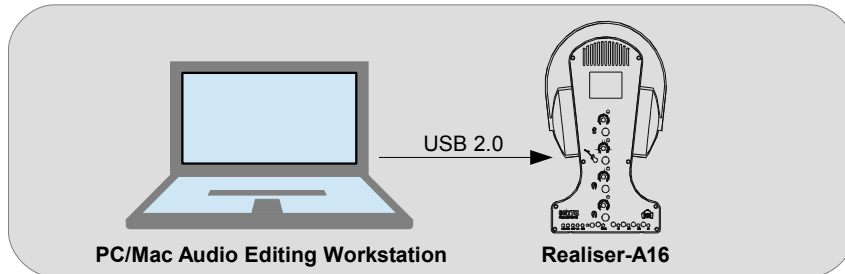

- Watching 5.1 / 7.1ch movies
- Monitoring up to 16ch of immersive 3D audio at a digital audio workstation ASIO/PC, native/Mac

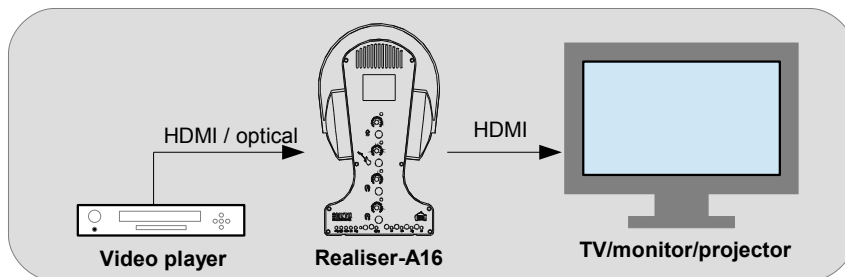

- Watching movies in the home
- Monitoring of legacy Dolby Digital and DTS formats (5.1 / 7.1) and Dolby Atmos, Auro-3D and DTS-X audio formats from DVD/Blu-ray/Ultra HD Blu-ray players

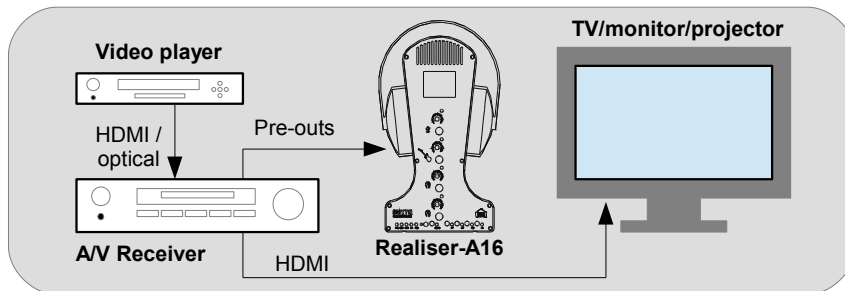

- Watching movies in the home with an external AV receiver
- Monitoring decoded legacy Dolby Digital and DTS formats (5.1 / 7.1) and Dolby Atmos, Auro-3D and DTS-X audio formats through an external AV receiver

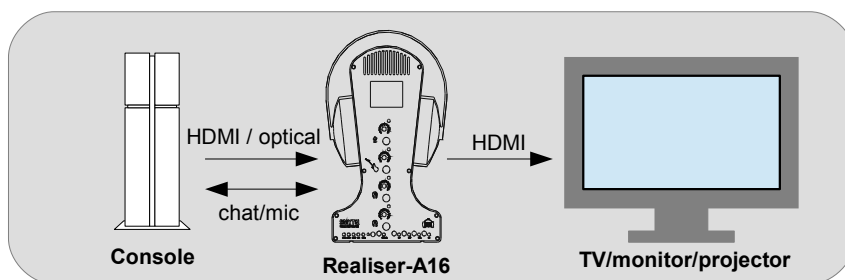

- Console or PC video gaming 5.1 / 7.1 / DTS / Dolby Digital / Dolby Atmos 7.1.4

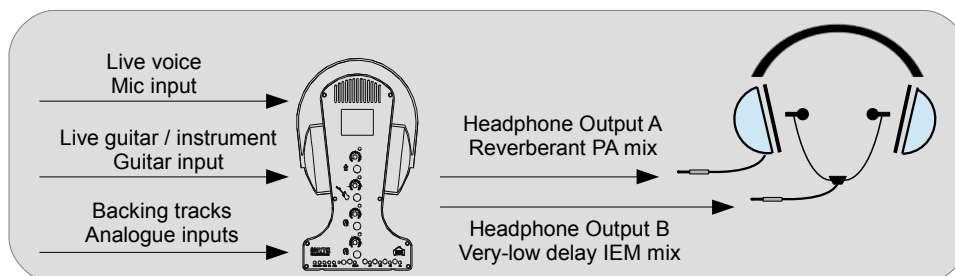

- Live music / concert hall / live gig performance training with or without IEM monitoring

## Functional Block Diagram

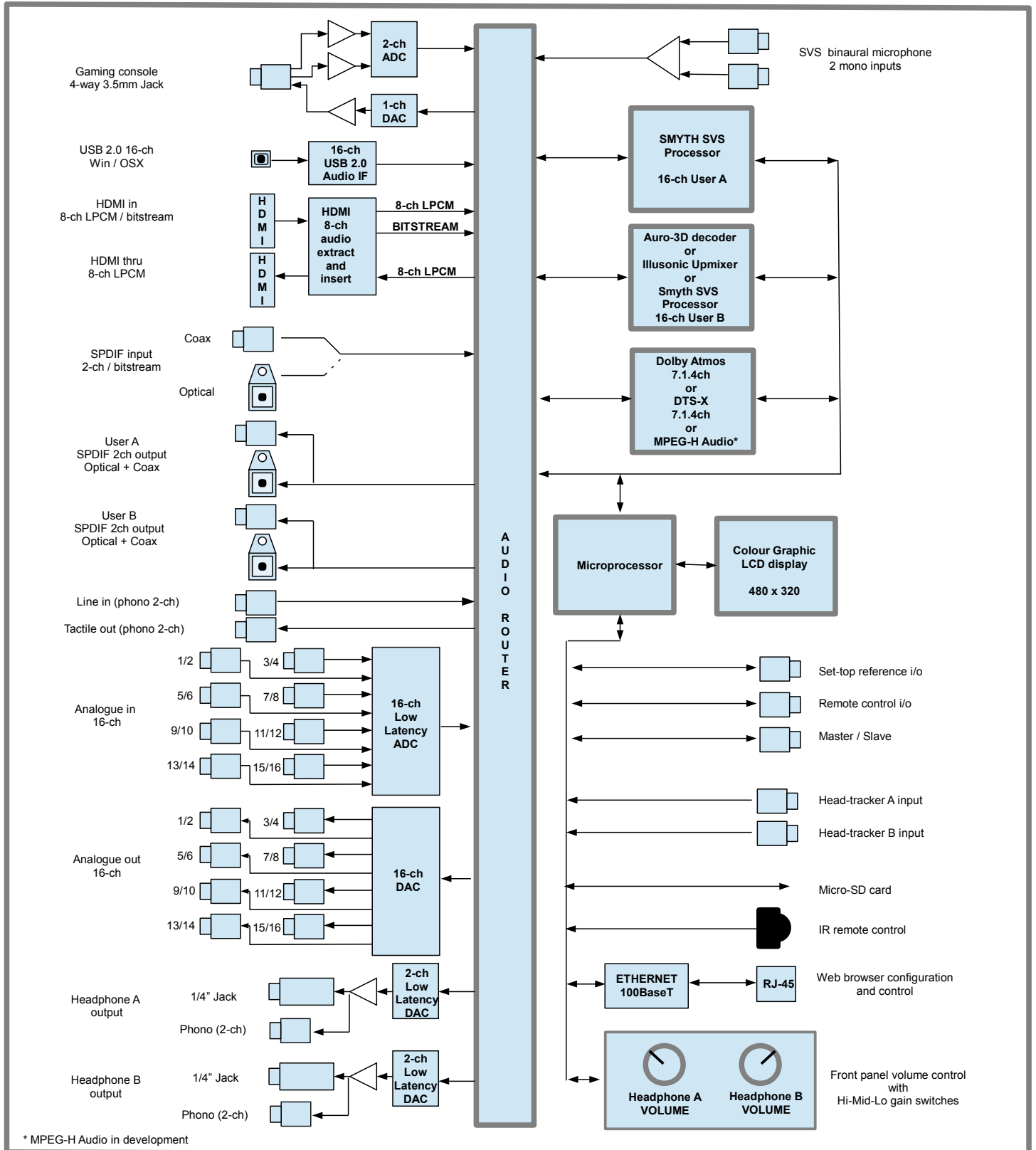

## Rear panel physical connections

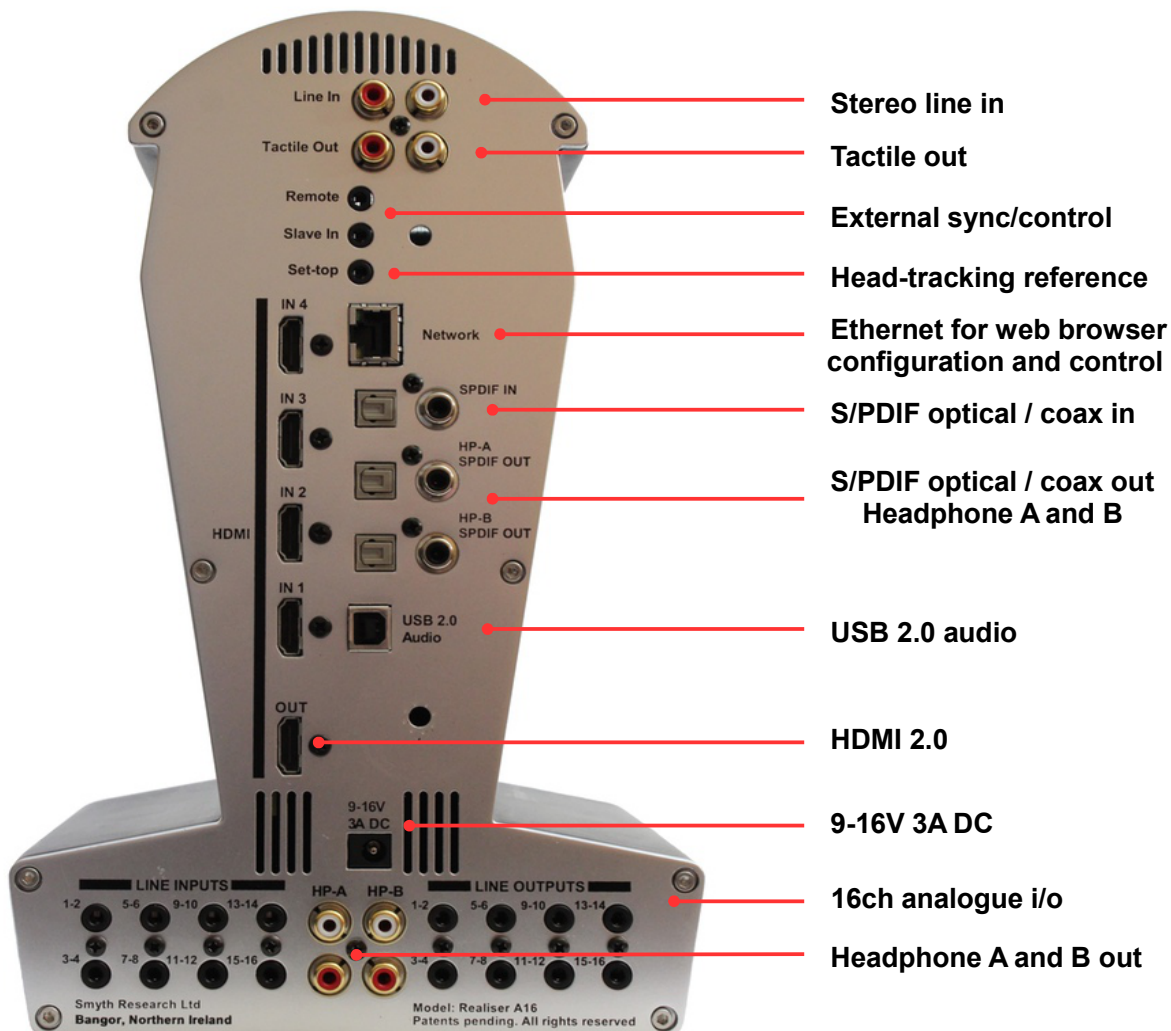

Rack-mountable version

Removeable rack ears

2U height

